

CENTATEQ P-210

The flexible all-rounder.

Powerful from 3-axis to 5-axis solutions.







Be on the safe side with HOMAG

You should not experiment with investment in a new machine or plant. Rely on the competence, experience and reliability of a strong partner – rely on HOMAG.

YOUR SOLUTION

CONTENTS

- 04 Operating concept
- 07 Options convenience package & safeScan
- 08 Quality
- 10 Processing examples
- 12 Drilling technology
- 14 Main spindle technology
- 16 Changer systems
- 18 Aggregates
- 20 Console table
- 24 A-FLEX table
- 26 MATRIX table
- 30 Software
- 34 Life Cycle Services
- 35 Apps and digital assistants
- 36 Configurations
- 38 Technical data

Operation made easy

WORKING ON A CNC MACHINE HAS NEVER BEEN SO EASY AND CONVENIENT:

All of the essential functions are directly in view and mounted directly on the machine. Thanks to the large window everything is always in view. Access to the table is free, no disturbing fences are required to the left and right. Fully implemented bumpers combine productivity, security and access to the machine.



Convenience package (Option) – relieving the working area, starting, pausing and continuing the program, raise and lower the hood can easily be activated via pressing a button directly at the machine. The light indicator of the push buttons shows the status at any time.



Maximum insight into the machine and at the same time optimal protection of the operators by large windows. Drill changes and service can be carried out easily from the front side of the machine.



Switch bar instead of foot switch – no searching and moving the foot switch – stops, output stroke rails and vacuum clamping can be activated easily.

1 Chip conveyor belt (Option): Simple disposal of the offcuts and chips using the integrated chip belt. A waste box can be easily pushed onto the belt from the front.

3 Convenience package (Option): Relieving the working area, starting, pausing and continuing the program, raise and lower the hood can easily be activated via pressing a button directly at the machine. An integrated proximity scanner for intelligent pausing is included.

2 Deposit position to the left on the machine for clamping equipment.

5 safeScan (Option): Scanner for contact-free protection of the positioning of the automatic table and feed reduction in conjunction with the Speed Pack.

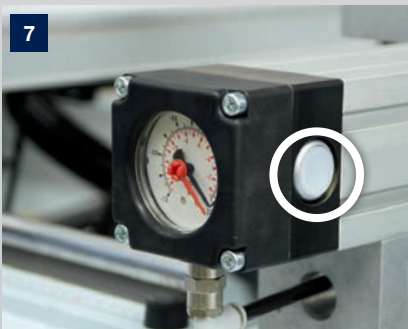
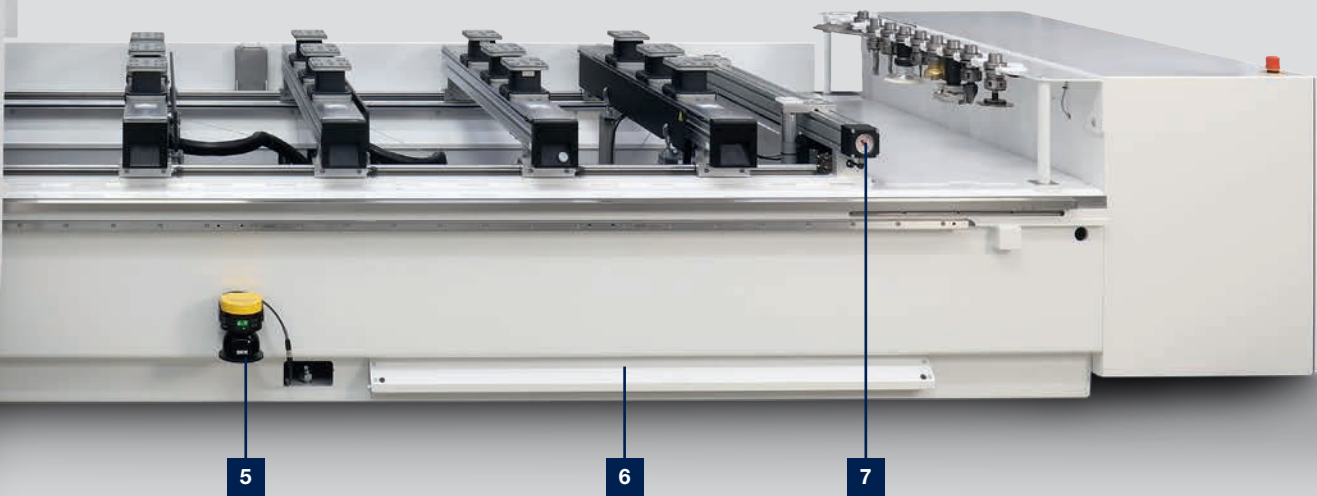

Button for program start – each one at the left and right hand stop profile act as program start for the processing.

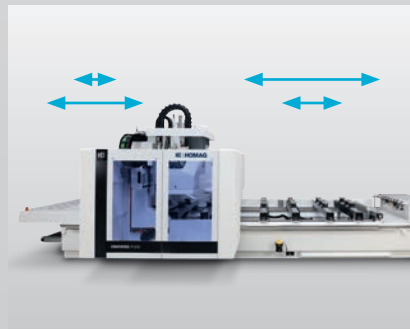

Dynamic alternating operation without fixed field division. This means that even in the case of long parts on one side of the machine a short part can still be placed on the other side.

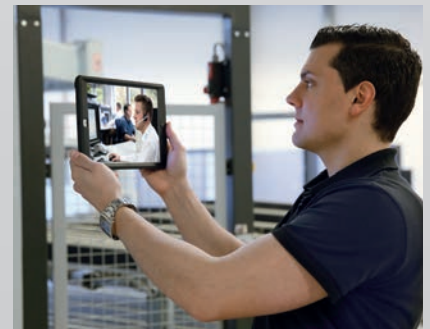

Smart support for support and maintenance using the service pad and display of machine status on smart devices.



UPS (uninterruptible power supply)

- Protects the computer against damage in case of mains interruption



Air-conditioning (optional)

- Air-conditioned cabinet



ecoPlus – energy saving function

- Simple activation of the stand-by mode
- Vacuum pump is switched off (savings of up to 12%)
- Reduction of compressed air (savings of up to 6%)

Option: Convenience package

Machine-related handling taken literally. Program start, pausing, relieving the working area and lifting the dust extraction hood can be directly effected by buttons at the gantry housing. The additional proximity scanner stops a program before it gets to bumper contact. Via keystroke, the program is continued at the same position.

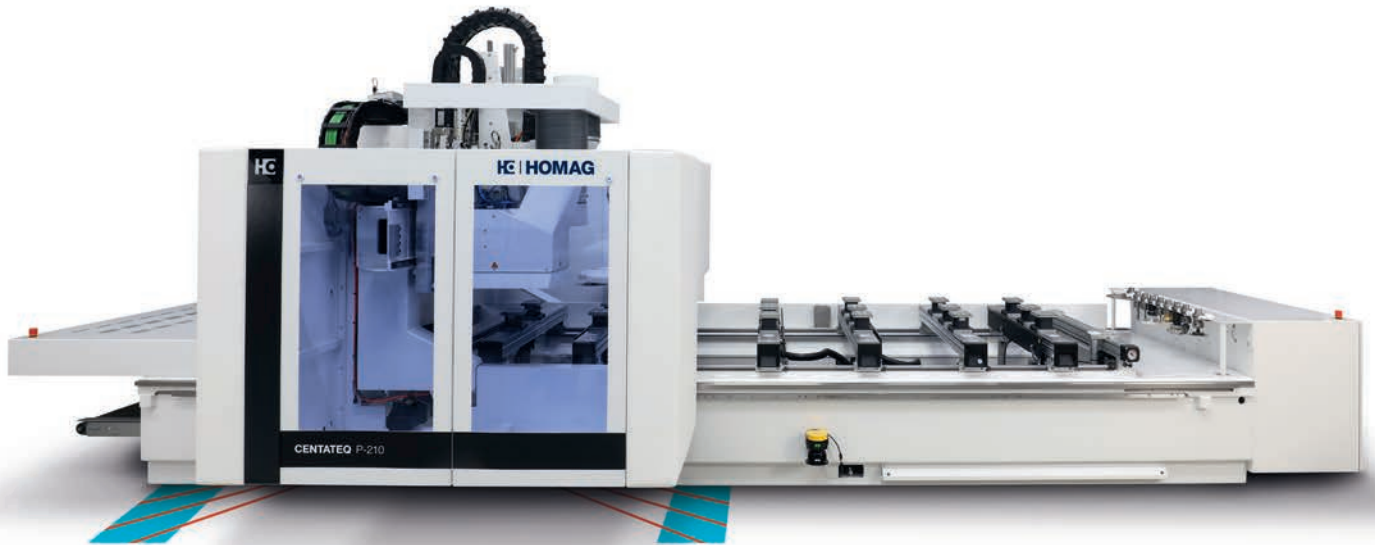

Option: safeScan

Scanner for contact-free protection of the positioning of the automatic table and feed reduction in conjunction with the Speed Pack.

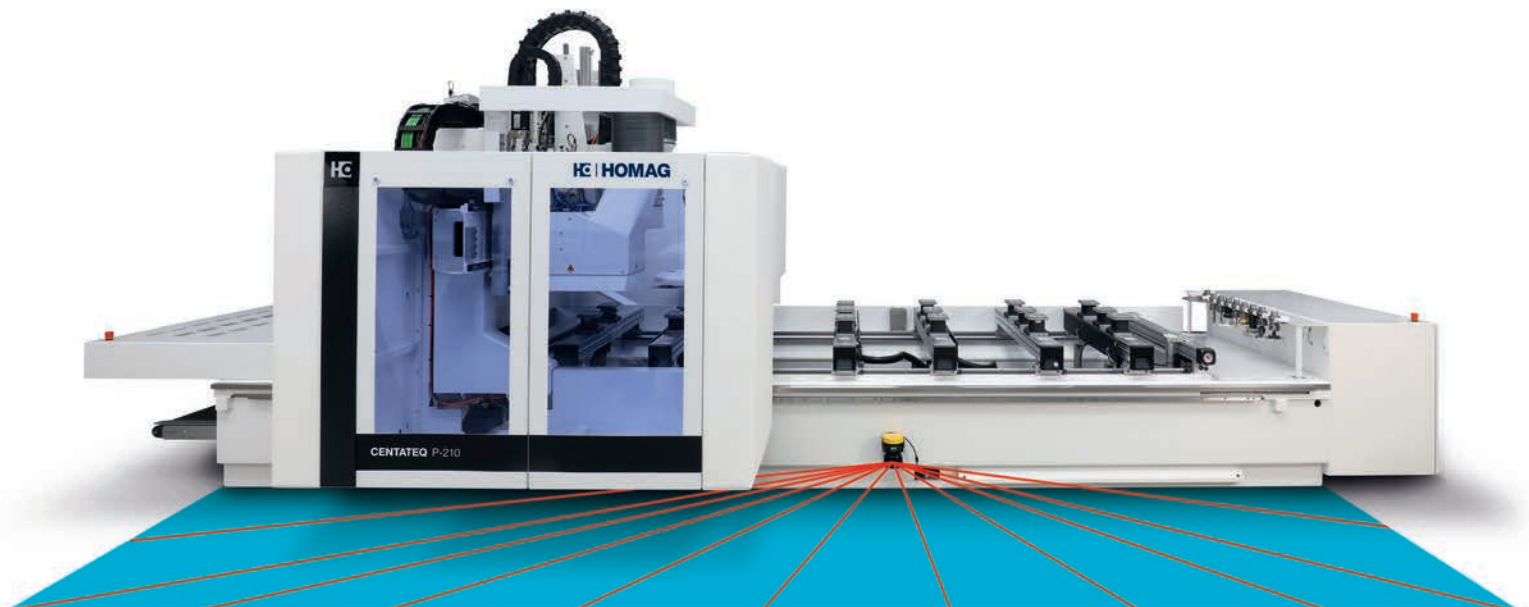

Quality and innovation down to the last detail

Innovative solutions for every task. Superior technology from the start. Every customer benefits from HOMAG system competence. The sum of decades of experience in machine and plant engineering goes into our machining centers.

Identical system components, uniform control technology and ergonomic operation ensure more productivity. The latest technologies for the variable high-quality workpiece shapes.

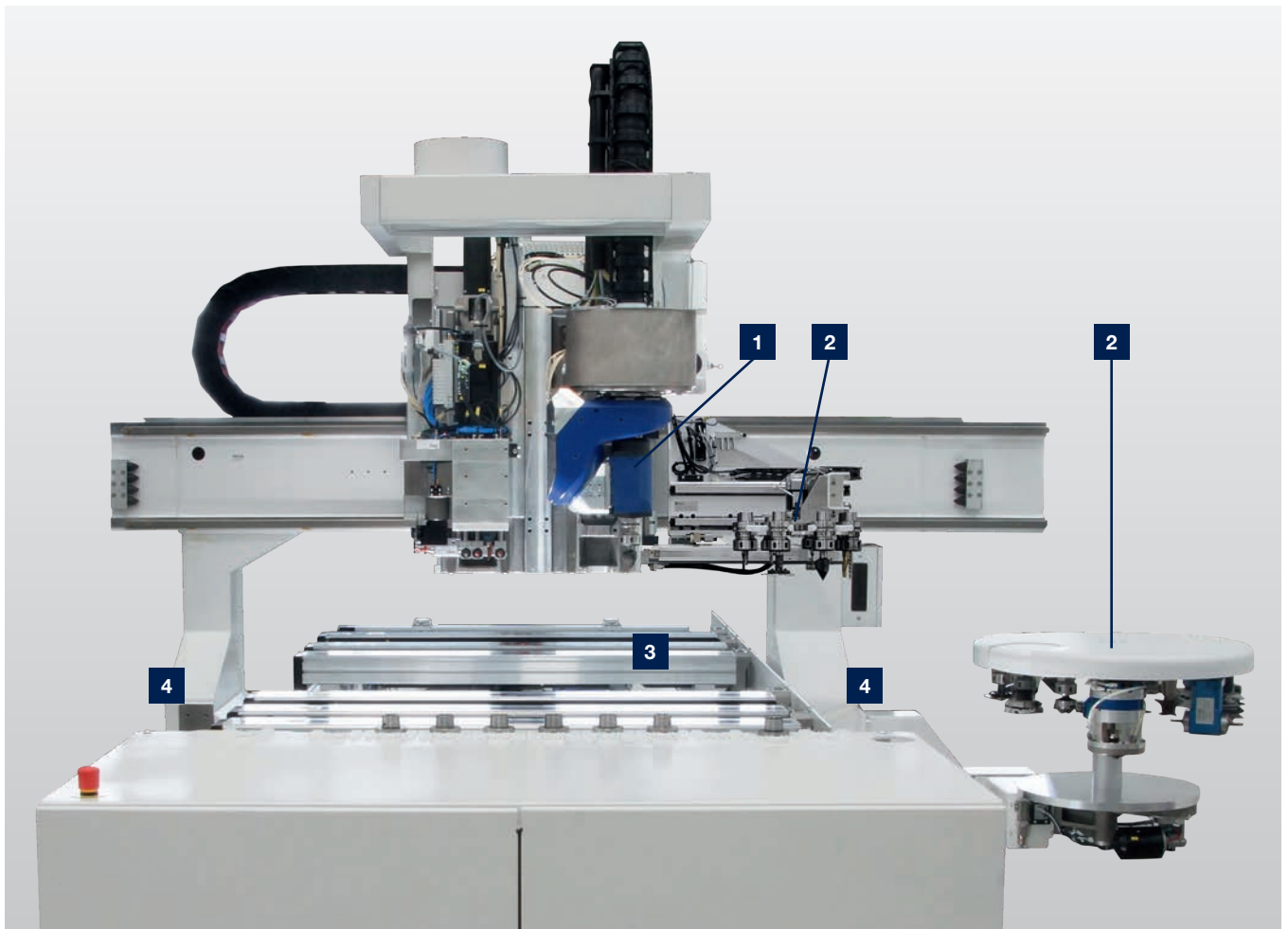

1 Powerful 4- and 5-axis routing spindles

2 Tool change systems traveling for high capacity and fast access

3 Console table with high-precision guides and robust insertion aids

4 2 synchronised digital servo-drives in X-direction guarantee highest precision



Effective suction at low connected load thanks to optimized detection and removal of chips. The hood is stepless with adjustable by motor.

Two separate Z axes for drilling head and working spindle permit rapid alternating drilling head and working spindle application. A drive unit moves only one unit over the full axis length.

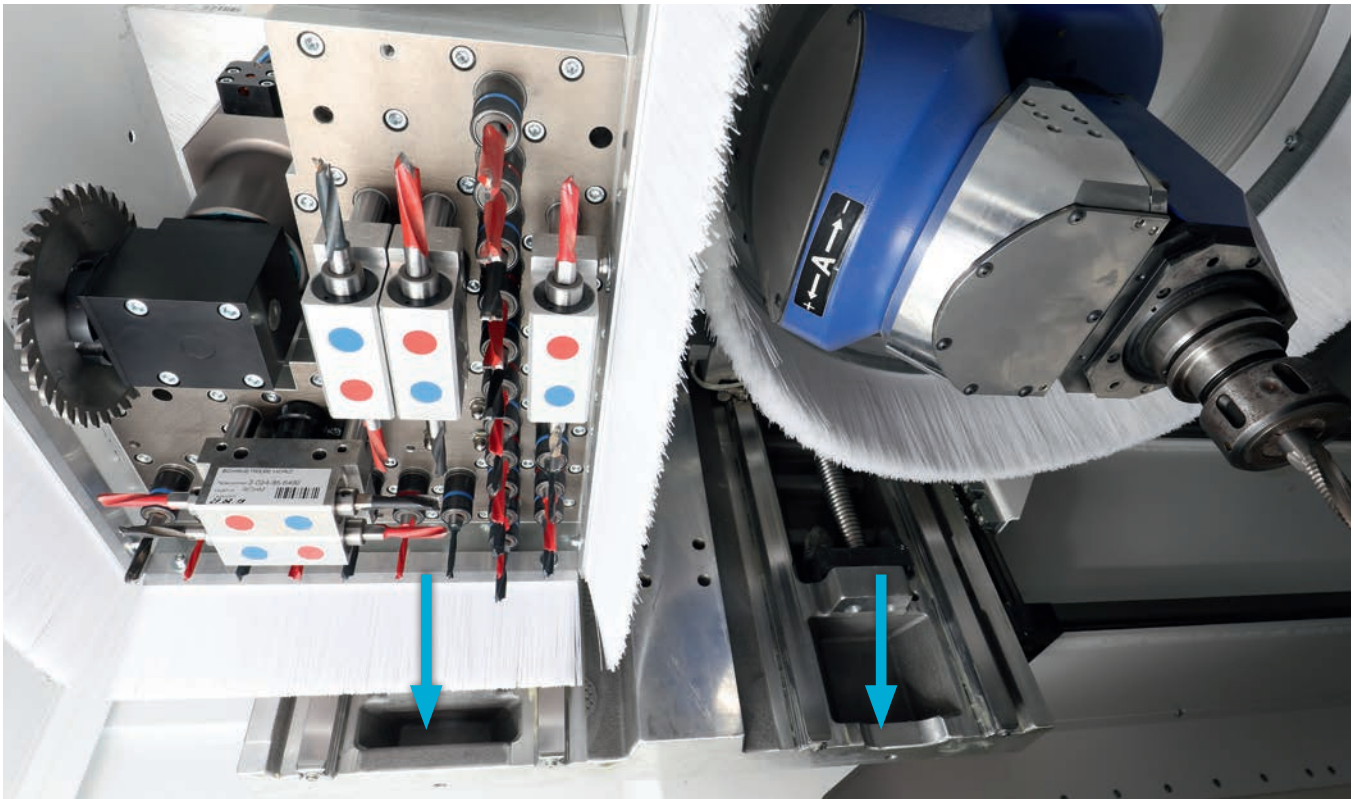

Mobile operator terminal with 24" full HD multitouch display can be moved freely. To the left or right of the machine, or for the run-in directly in front of the machine – the terminal is always at the right place.

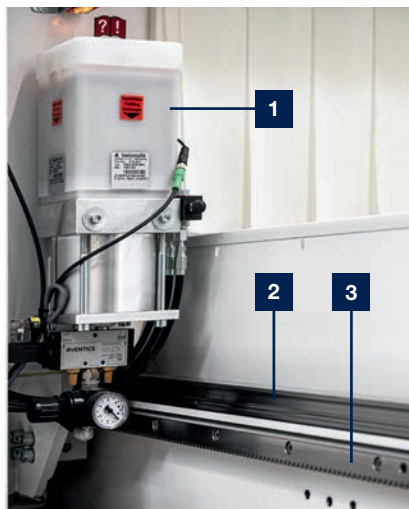

- 1** Automatic central lubrication of all main axes
- 2** Covered linear guide with closed guide carriage
- 3** Rack and pinion drive systems in X and Y

Whatever you want

Deciding in favour of a HOMAG machine means investing in a highly efficient processing center with the capability to fulfil wide-ranging different manufacturing requirements. Each machine is a complete system guaranteeing maximum output and efficiency every time – no matter how individual your production requirements are.

3- and 4-axis applications

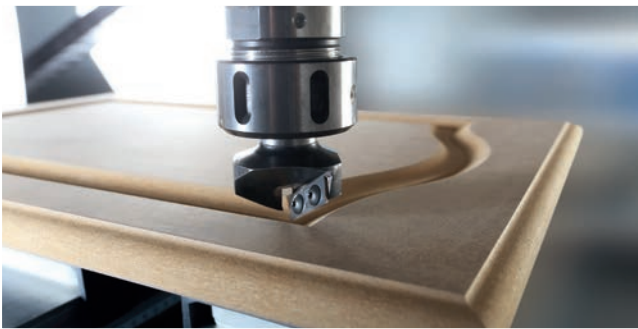

Profiling furniture fronts



Routing lock cases



Cutting mitre cuts



Cutting recesses for connecting fittings

5-axis applications



Mitre cut with high cutting depth for frames



Routing of shaped wood



Chamfer cutting on a table top



Square corner cutting for a glass rebate

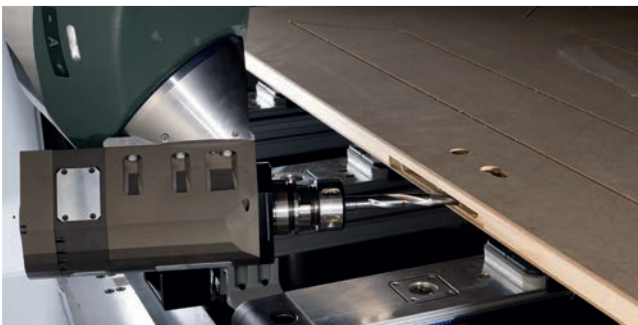

Lock case routing

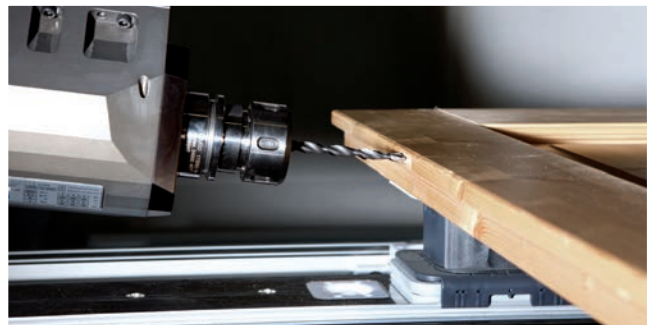

Step drilling for drill-in hinges



Routing of a dovetail joint for upright / transom constructions



Holes for piling at narrow angles

HOMAG drilling technology: The best of the best

High-speed drilling technology, patented clamping of the spindle and quick-change system for tools. Precise drilling, fast cycles, maintenance-free and durable construction.

Additional optional attachments expand the machine's range of applications.

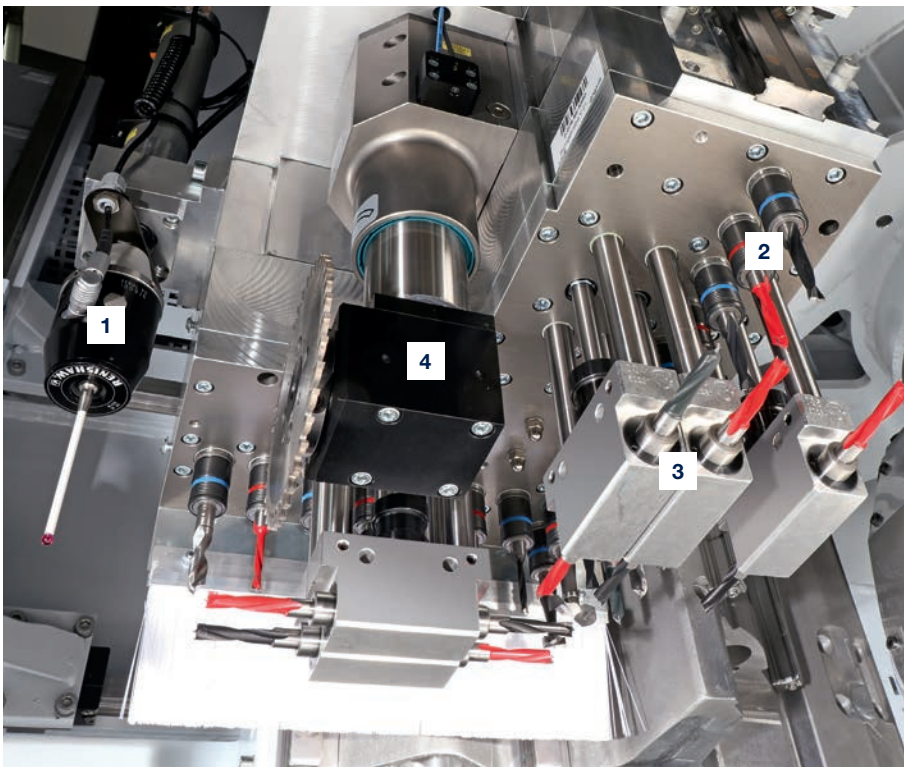

- 1** Measuring device to identify the relevant actual dimensions in X, Y, Z with automatic offset correction in the processing program (optional).
- 2** Vertical drilling spindles
- 3** Horizontal drilling spindles
- 4** Grooving saw

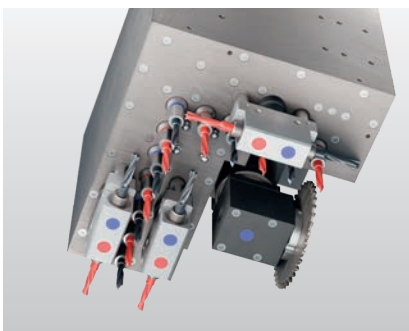

Drilling gear V12/H4X2Y

- 18 drilling spindles [High-Speed 7500]
- 12 vertical drilling spindles
- 4 horizontal drilling spindles in X
- 2 horizontal drilling spindles in Y
- Grooving saw Ø 125 mm (0° / 90°)

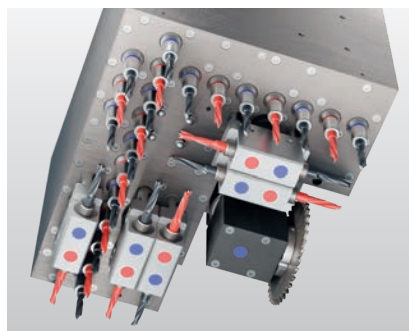

Drilling gear V21/H6X4Y

- 31 drilling spindles [High-Speed 7500]
- 21 vertical drilling spindles
- 6 horizontal drilling spindles in X
- 4 horizontal drilling spindles in Y
- Grooving saw Ø 125 mm (0° / 90°)

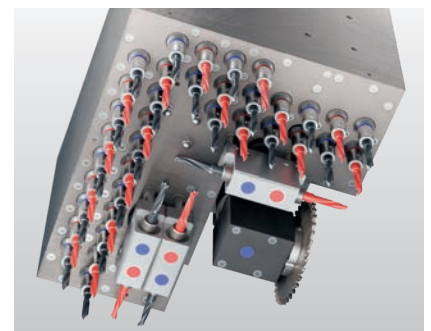

Drilling gear V36/H4X2Y

- 42 drilling spindles [High-Speed 7500]
- 36 vertical drilling spindles
- 4 horizontal drilling spindles in X
- 2 horizontal drilling spindles in Y
- Grooving saw Ø 125 mm (0° / 90°)

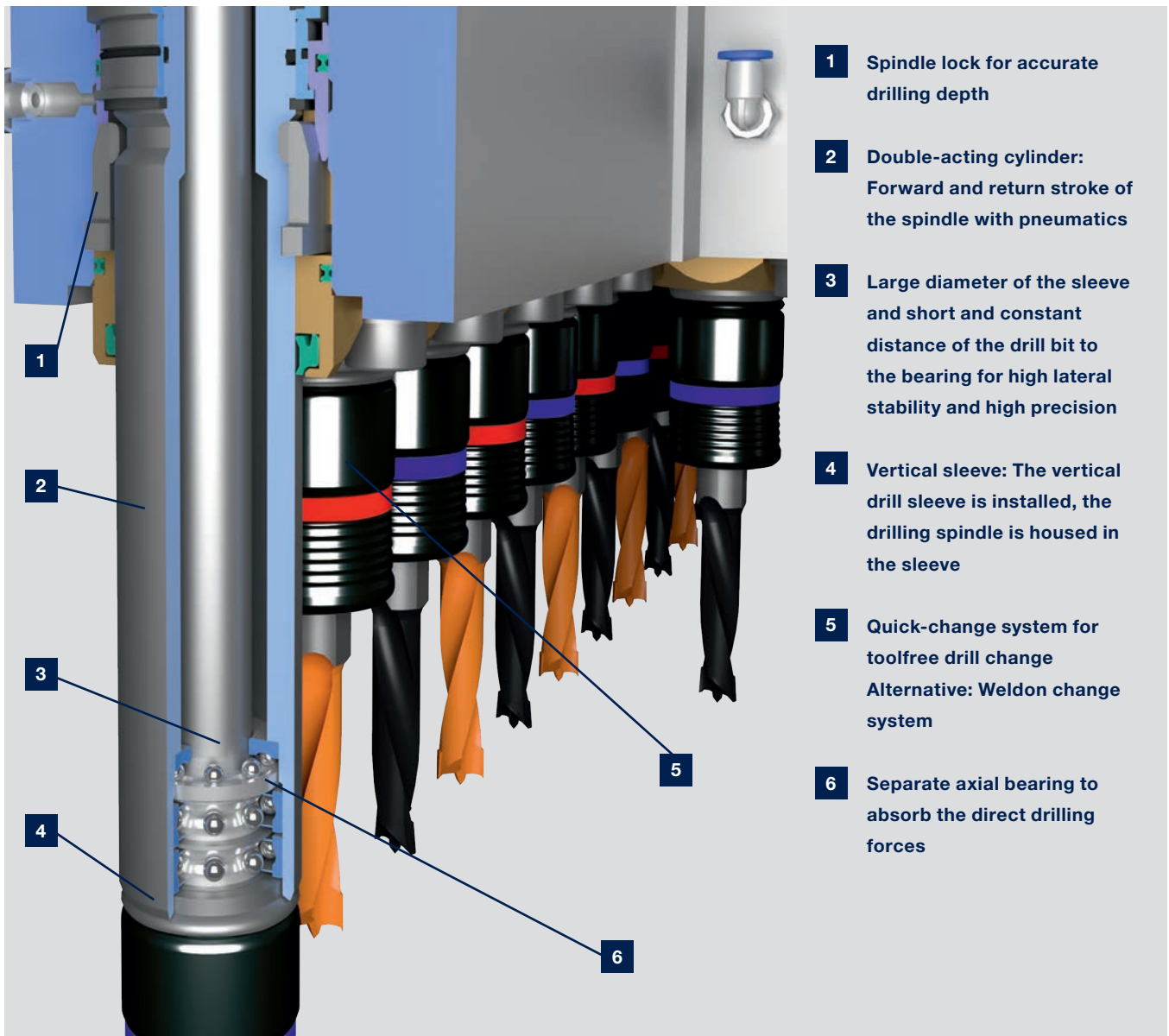

- 1** Spindle lock for accurate drilling depth
- 2** Double-acting cylinder: Forward and return stroke of the spindle with pneumatics
- 3** Large diameter of the sleeve and short and constant distance of the drill bit to the bearing for high lateral stability and high precision
- 4** Vertical sleeve: The vertical drill sleeve is installed, the drilling spindle is housed in the sleeve
- 5** Quick-change system for toolfree drill change
Alternative: Weldon change system
- 6** Separate axial bearing to absorb the direct drilling forces



Weldon change system for a drill change with tools



Patented quick-change system for a drill change without tools to reduce setup times.

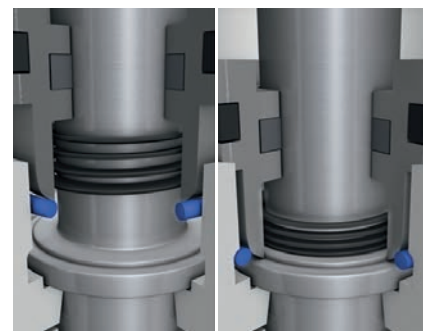

Automatic spindle lock — patented system for a drilling depth that is always accurate for numerous different materials. With speeds from 1500–7500 rpm for high feed speeds or short drill cycles.

Main spindle technology

We are setting standards with our main spindle technology, increasing the performance and flexibility of our machines. Our highlights are the vibration sensors, which avoid damage to the routing spindles, and the 5-axis technology. Select the spindle suitable for your current and future product range.

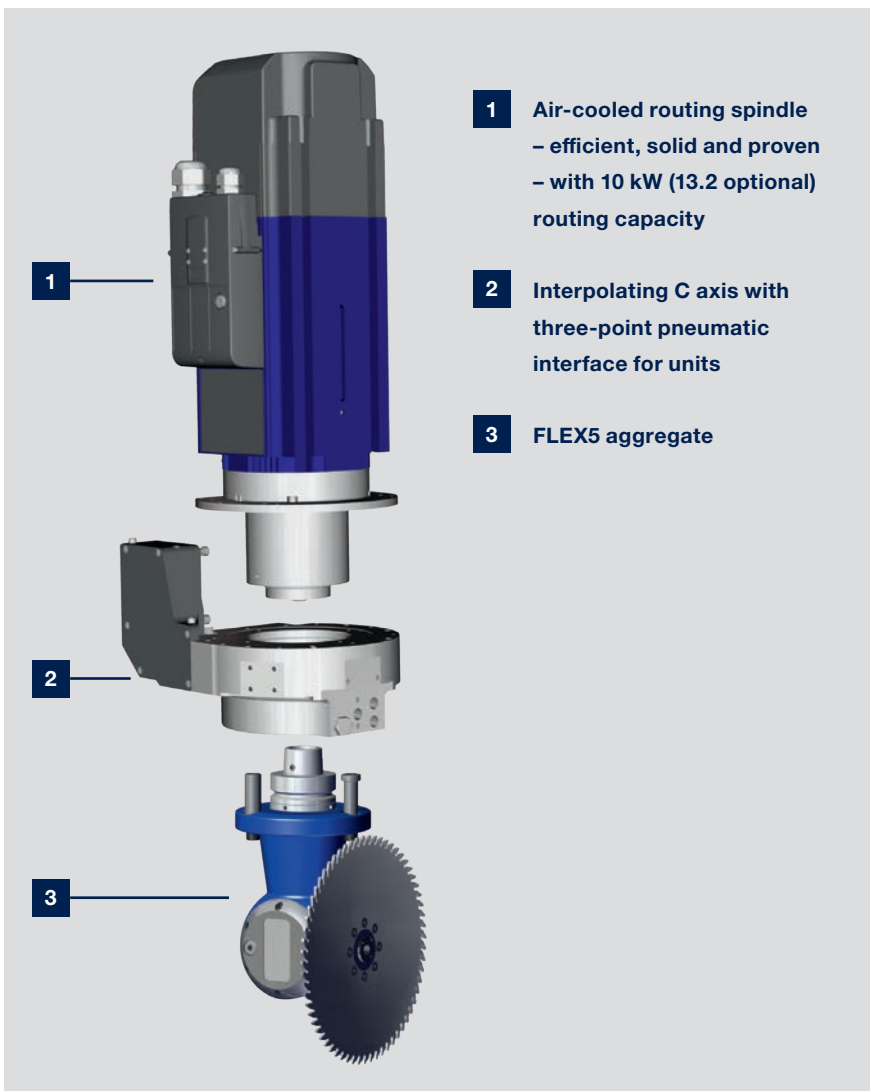

4-axis routing spindle with units interfaces, which open up almost unlimited production opportunities. With patented technologies the range of tasks can be expanded at any time.

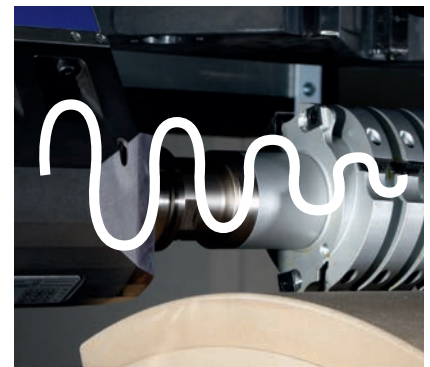

Liquid cooling and spindle sensor (optional for DRIVE5CS) – liquid-cooled routing spindles with hybrid storage offer a long service life. An additional vibration sensor detects tool unbalances and protects the spindle against overloading, due to high feed speeds for example.



Sawing, routing, drilling at any angle – FLEX5 aggregat with automatic angle adjustment. A unique unit for 4-axis spindles, which covers over 90% of 5-axis applications.



The smart DRIVE5CS 5-axis-head – compact design with short power transmission. Comprehensive technology on small space without limits regarding the processing range. Liquid-cooled spindle with 10 kW (as option 12 kW routing capacity) for efficient operations. The short design provides more space for processing (e.g. with a 350 mm saw blade, under the hood).

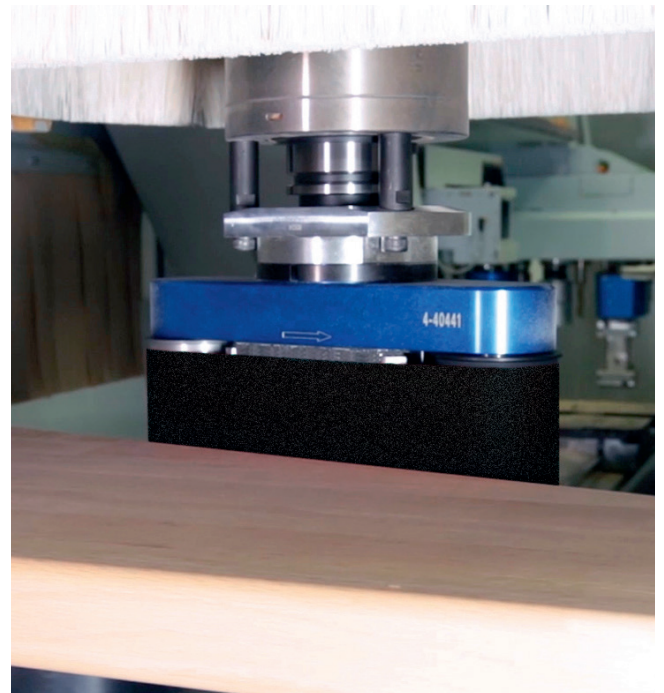

Pneumatic interface – the patented interface with 3-way support on all C-axes and optionally on the DRIVE5CS enables the use of traced units, e.g. for precise rounding off at the top and bottom no matter the thickness tolerances.

Tool changer systems

Simple flexibility

All neatly stored away for quick access. Tool changers provide the basis for the flexible deployment of tools and units, also for large saw blades or heavy processing tools. Right from the beginning you get up to 24 tool changing places.



14-fold tool changer moving in X-direction. Also for saw blades with a diameter up to 300 mm.

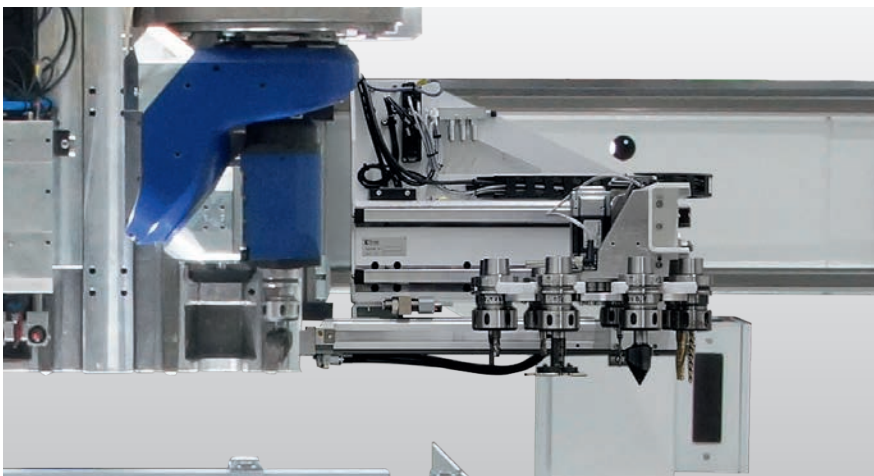

8-fold tool changer moving in X- and Y-direction



Linear changer

- Additional tool change magazine, with 10 slots and integrated tool transfer station, laterally mounted
- One slot is prepared to accommodate a saw with a diameter of 350 mm



Tool length control (optional)

- Suitable for length measurement of shank tools
- Following the tool change via the tool pick-up station a tool length control is carried out and compared with the integrated tool database



Tool pick-up station

- Safe and quick fitting of the tool change magazine
- High safety by sensor monitoring if the tool pick-up station is free or occupied

Units

Excellent processing quality and new standards for speed

The HOMAG units provide numerous innovative technologies. They can be combined and precisely coordinated to your specific application situation. Even special tasks are worked out safely and efficiently.



Corner notching unit

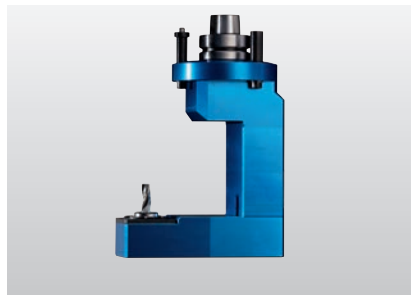

Underfloor routing unit



Drilling/routing unit



Drilling/routing unit



FLEX5 drilling/sawing/routing unit

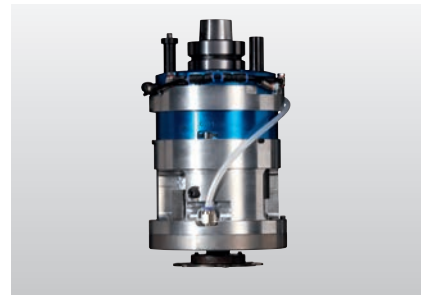

Routing unit



Lock-case routing unit

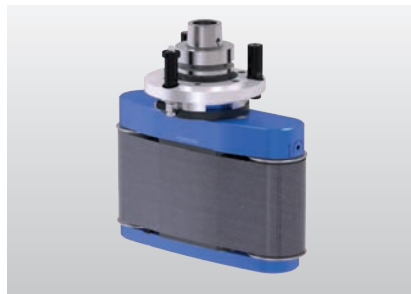

Belt sanding unit



Eccentric sanding unit



More information
you find on our website in the brochure
»Unit and Clamping Element Catalogue«



Electrical interface for the side linear changer for parallel heating of the edge banding unit.

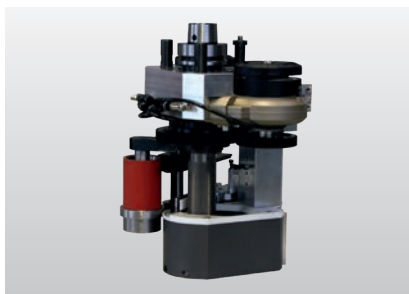

easyEdge edge banding unit
The clever solution for edging with small quantities for veneer, ABS, PP, PVC, melamine and thin edges.

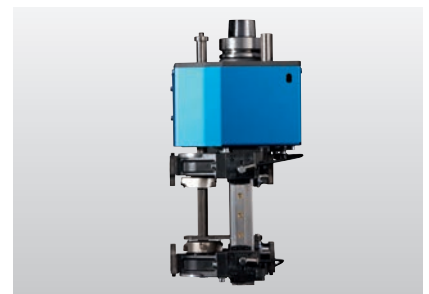

Combined flush trimming and scraper unit for flush trimming and scraper post-processing of the edge profile. The three-sided tracing of the unit balances out workpiece and edge tolerances and guarantees high processing quality incl. tools.

Console table

Flexible and fast

THE CLASSIC, DUAL-CIRCUIT VACUUM SYSTEM.

The patented system of magnetic valves allows vacuum cups and other clamping devices to be placed on the consoles in arbitrary numbers and at arbitrary positions. The K-table is the ideal solution when flexibility, secure clamping of very

different parts and fast exchange of the clamping systems are required.

The rapid, precise and especially easy positioning of the suction unit is enabled by the LED or laser positioning aid.

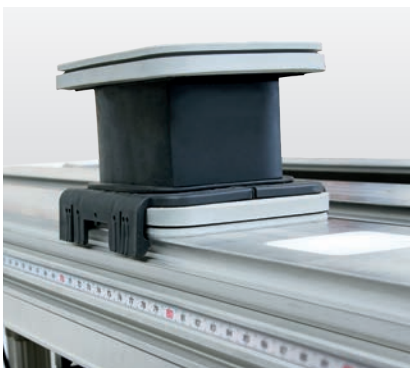

Measuring tape for positioning the suction units.

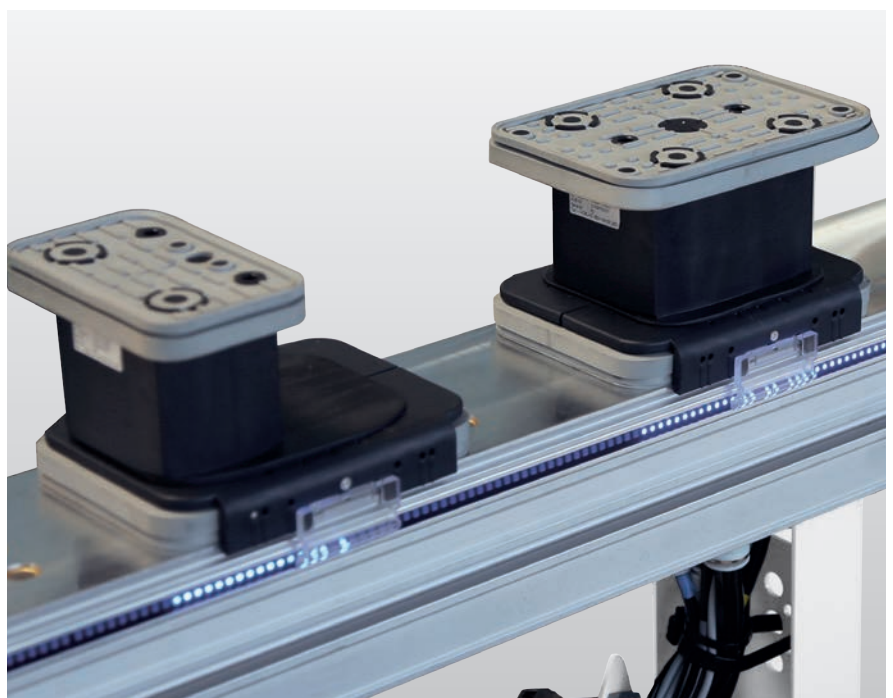

LED system – fast and safe setup. LED light strips show the suction cup type and its orientation as well as the position of the suction cups and consoles.



LASER positioning aid – vacuum suction units are indicated by a laser cross-hair. The workpiece contour can be “moved” as a positioning aid for free-formed workpieces.



Laser projection of the clamping equipment and the workpiece contour for optimal utilization and simple positioning of unprocessed parts that cannot be aligned on the stops.

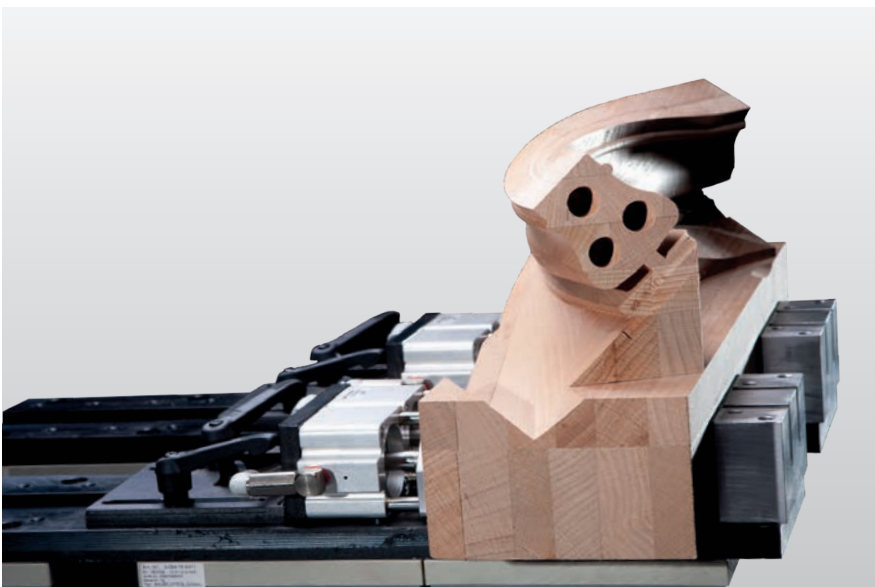

Clamping unit ensures safe and quick clamping of jambs and scantlings.

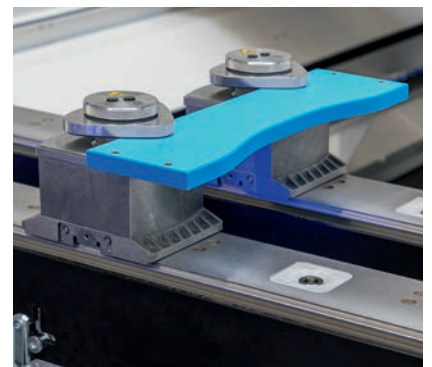

Multi-clamp for dual-circuit vacuum system. Vacuum-actuated clamping element for clamping strips and elements.

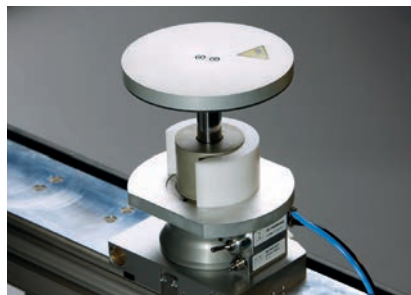

PowerClamp E.g. for processing of solid wood components on 6 sides (lowerable base plate).



Base plate module for mounting on the consoles as the basis for special clamping fixtures.

Accurate and safe with the console table

Thanks to the patented system of solenoid valves, vacuum suction units and other clamping equipment can be used in any number and in any location on the consoles. Application-optimized stops and insertion aids ensure precise placement and positioning of the components.

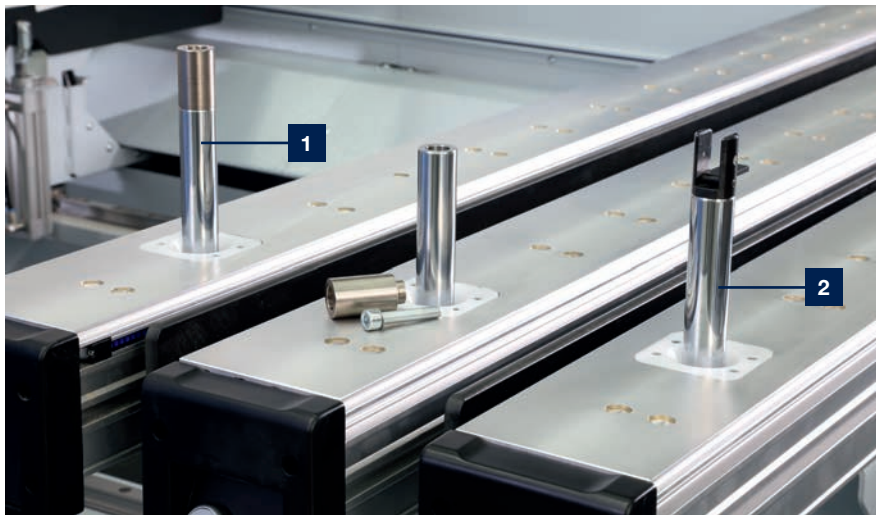

- 1** Stop pin
- 2** Stop pin for covering layer overhang



Electronic cylinder surveillance
Improved safety by electronic surveillance of all stop cylinders.



Stop pin for covering layer overhang
with end position monitoring to protect tools, units and machine operating personnel.

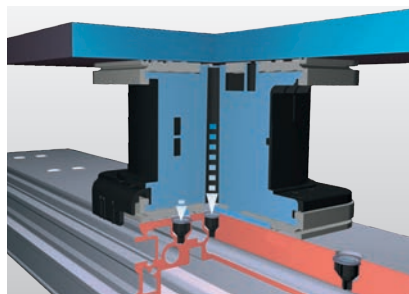

Dual-circuit vacuum system – exclusive vacuum clamping technique with double sealing flange for infinitely variable movement of the clamps along the console. The first clamping circuit fixes the clamp on the console and prevents unintentional moving, the second then keeps the material stably in position.



- 1** Easy adjustment of the side stops
- 2** Vacuum connection for templates
- 3** Pneumatic connection with 2-pressure control for 2 clamping rows (optional)
- 4** Button for program start integrated in the stop profile



Workpiece feeding rail Solid feeding rails to ease placing of heavy workpieces with 2 pneumatic cylinders. Due to the linear movement of the feeding rails, the workpieces are not moved away from the stops during lowering, regardless of processing at the front or rear stops.

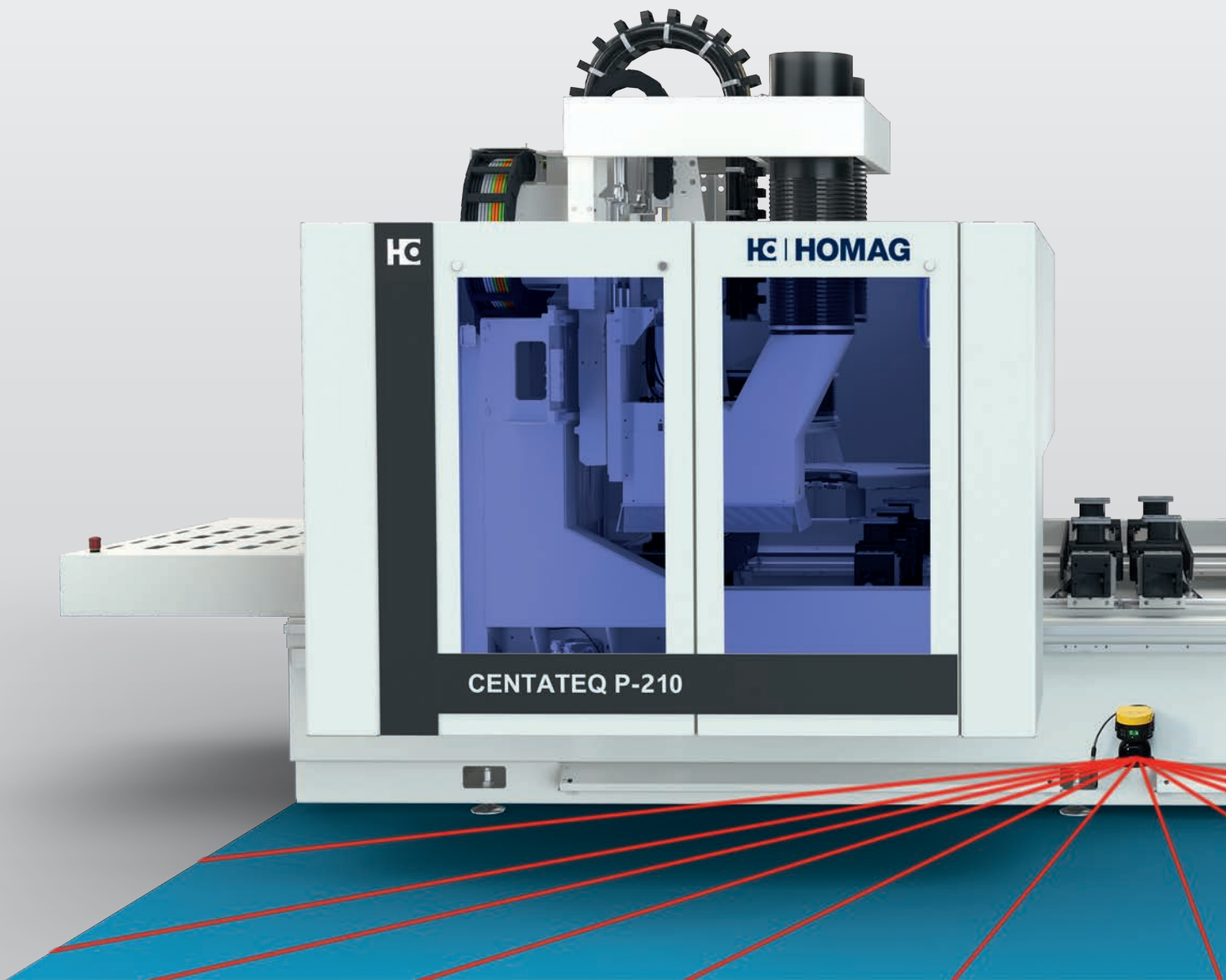

Floating instead of pushing

The vacuum cups move on an air cushion on the console. Nozzles at the front and rear of each cup blow dust and chips off the console for trouble-free placement and to help extend the life of the system.



All clamping devices available

The basis of the table is the proven 2-circuit vacuum system. Thus, in addition to the automatically positionable elements, all standard clamping devices can be used in manual operation.

A-FLEX table

Automatically at the right place

The A-FLEX table is the perfect combination of the console table and the automatic table. With the A-FLEX table, you automatically set up the consoles and vacuum cups while remaining flexible and universal in use. Thus, you are perfectly positioned for all requirements.

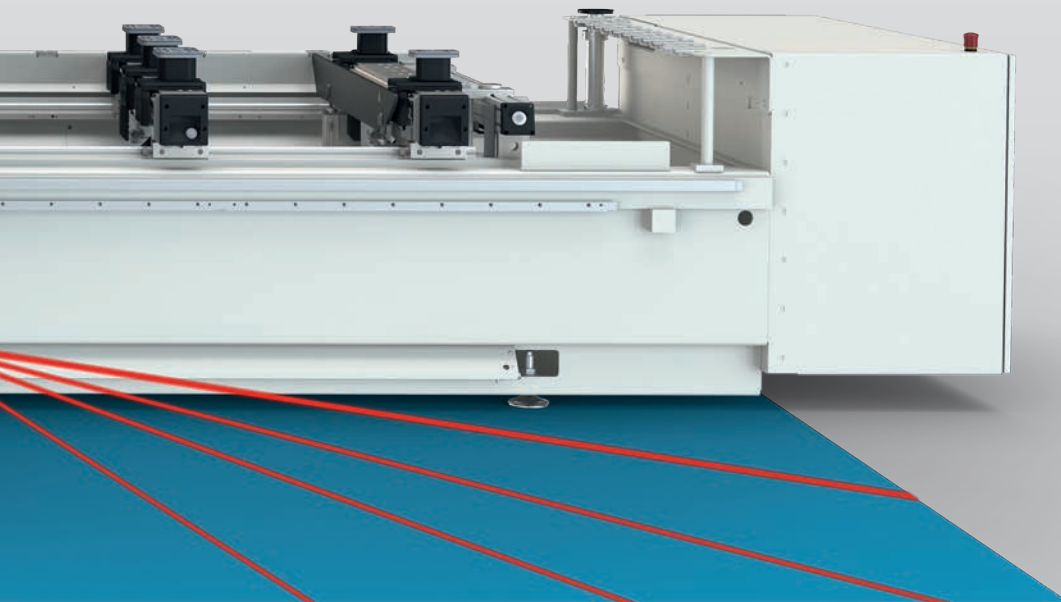

safeScan safety technology

This machine includes a scanner for contact-free protection. After start release, the table starts the cup setup independently when the operator leaves the safety area.

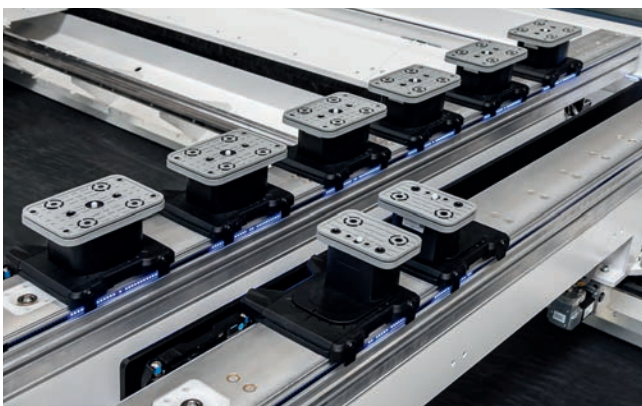

LED setup aid and free number of vacuum cups

Put on the right vacuum cups – correctly oriented and in the right order, always. The cups can be placed quickly and safely, assisted by the LED display direct on the console. The number of vacuum cups for each console is free, up to 8 can be positioned automatically.

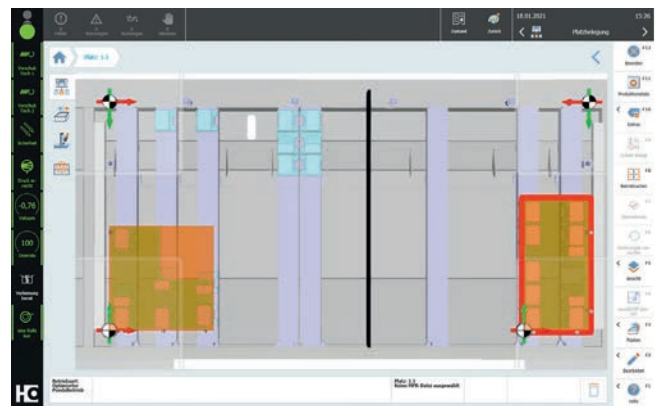

PC 87 slot assignment

The PC 87 slot assignment calculates the best vacuum cup arrangement for the clamping devices available on the machine.



1" vacuum connections with quick-open function by means of switch cabinet key, vacuum openings with precision thread for fixing clamps

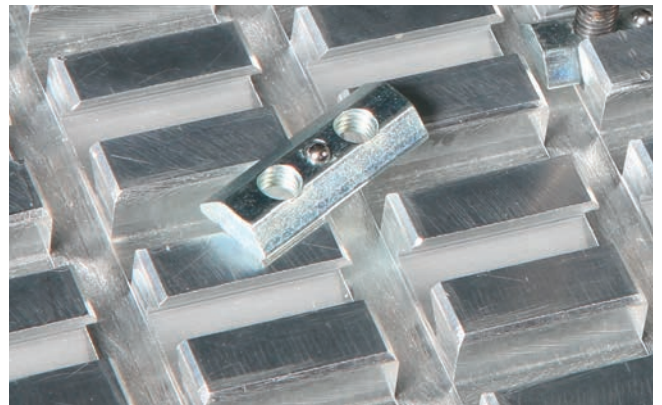

Slot nuts with thread for positive locking of clamping fixtures in the dovetail guide

MATRIX table

Versatile application

The grooved aluminium MATRIX table permits the positive locking of clamping elements and consequently reliable workpiece fixture even where high hogging forces are involved. The transmission of vacuum through the table construction optimizes distribution of the vacuum, reduces

leaks and transmission losses and does away with the need for complex installations. The MATRIX table is also suitable for aggregates due to different clamping elements with variable mounting heights.

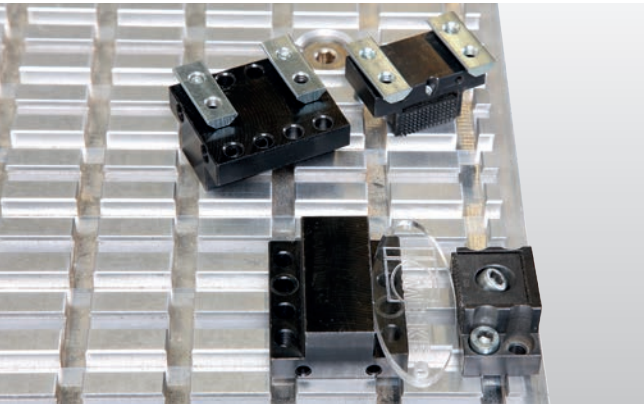
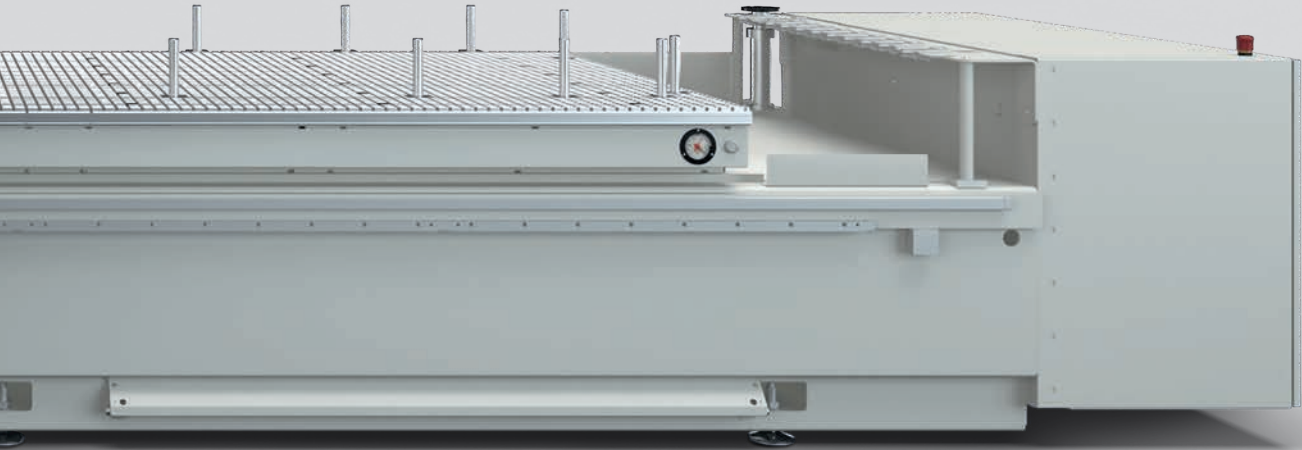

Aluminium MATRIX table with trapeze shaped grooves for interlocking and flexible fixing of all kinds of clamping aids

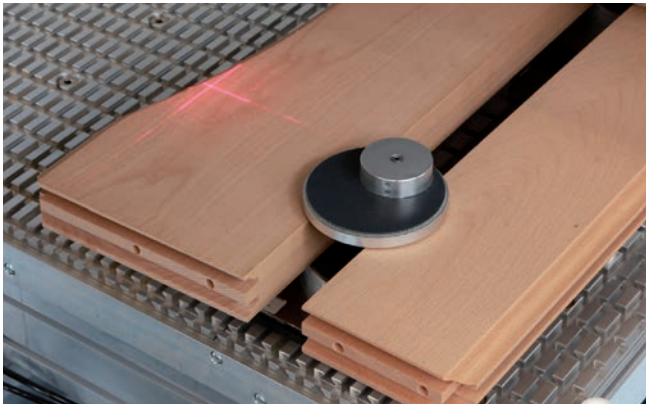

Laser positioning Routing contours can be processed via the cross-laser

MATRIX table

For Nesting and many other applications

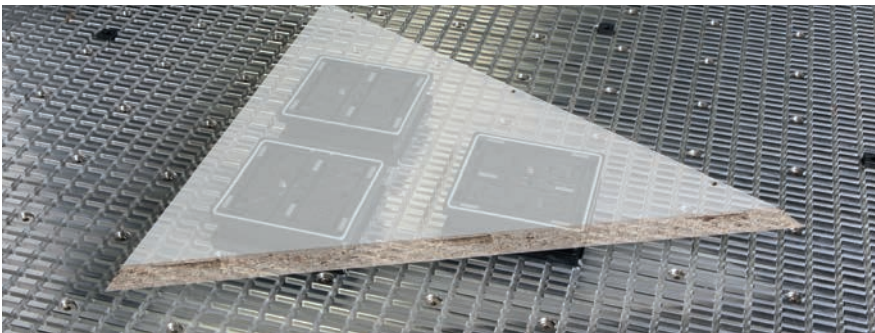

Vacuum clamp Vacuum clamping elements for insertion in the grooves of the MATRIX table

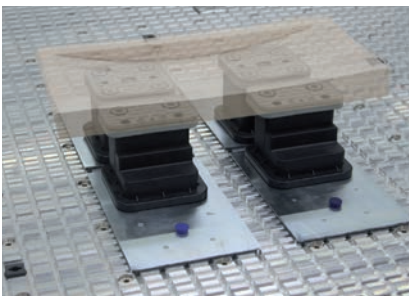

Maxi-Flex system System base plate for vacuum clamp that can be equipped as required

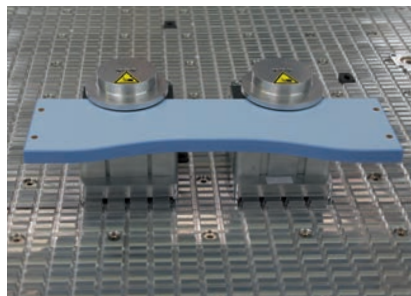

Multi-clamp Vacuum-actuated clamping elements for clamping strips and scantlings



Fixture using non-standard clamps The aluminium MATRIX table with dovetail guides guarantees precise, positive fitting clamping element fixture

With diverse types of vacuum blocks with different heights it is possible to carry out simple and quick horizontal processing on MATRIX tables, e.g. for doors. And when processing technical components and moulded parts, it is also possible to partly dispense with clamping templates.

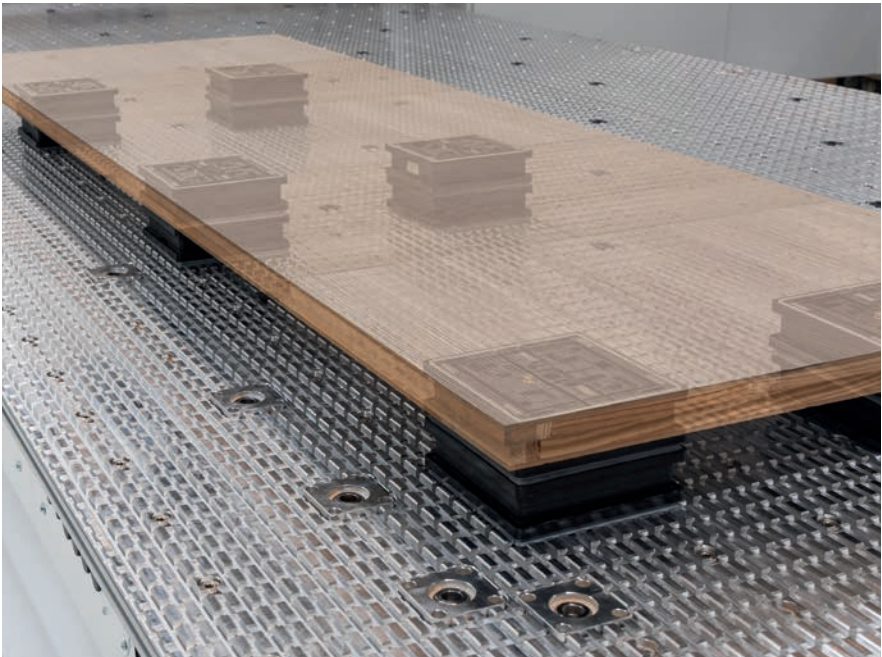
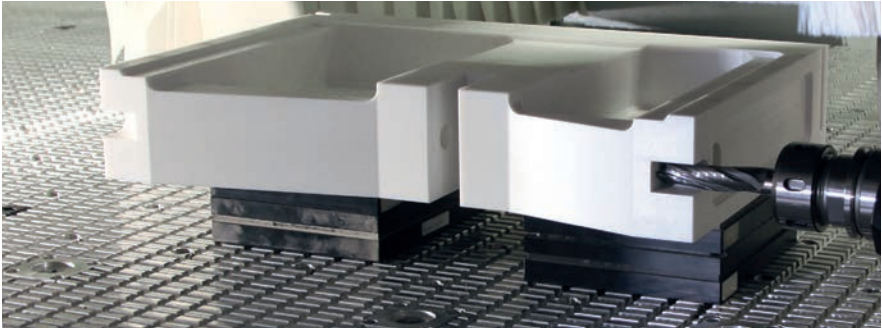

Nesting processing of panel materials: waste-optimized cutting to size and processing in the surface

HOMAG software solutions

The basis for simple and efficient operation

Our processing centers are one thing – the software to operate them conveniently and easily day-to-day is another. HOMAG software and control modules ensure maximum flexibility and operational safety. Naturally with HOMAG:

Interfaces to external programming and construction systems, auxiliary programs for nesting and modules for machine monitoring and performance tracking.

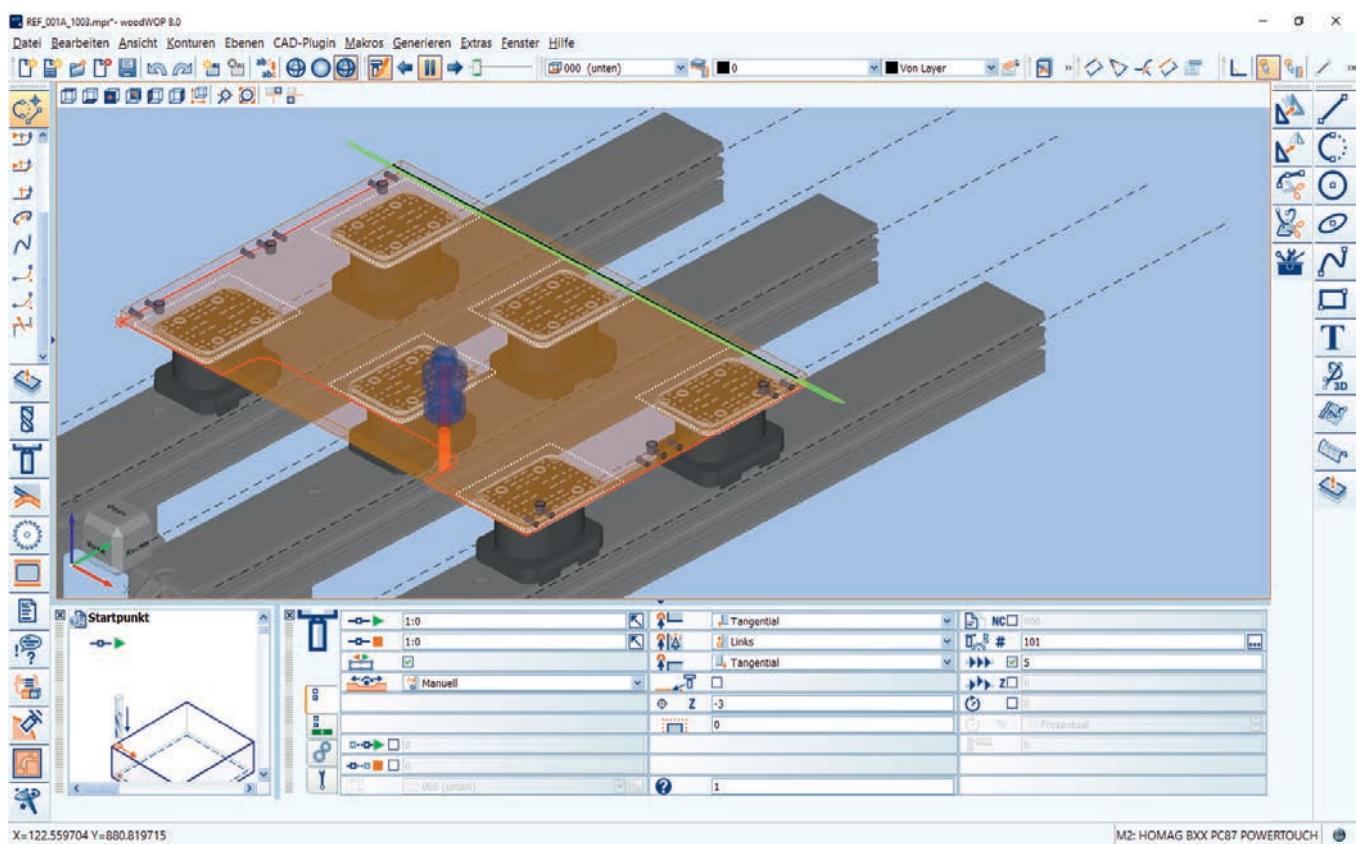

woodWOP – efficient thanks to fast programming

- Fast and intuitive operation thanks to simple, direct navigation
- Select from a choice of variables for flexible variable programming
- Quickly create individual subprograms
- Increased programming security through 3D images of workpieces, processing and clamping equipment
- Very easy to use through infinitely adjustable windows, multi-screen capability, language-neutral input screens, help images, etc.
- The largest online forum for CNC programming is: forum.homag.com



More information
you find on our website in the brochure
»Software from the HOMAG«

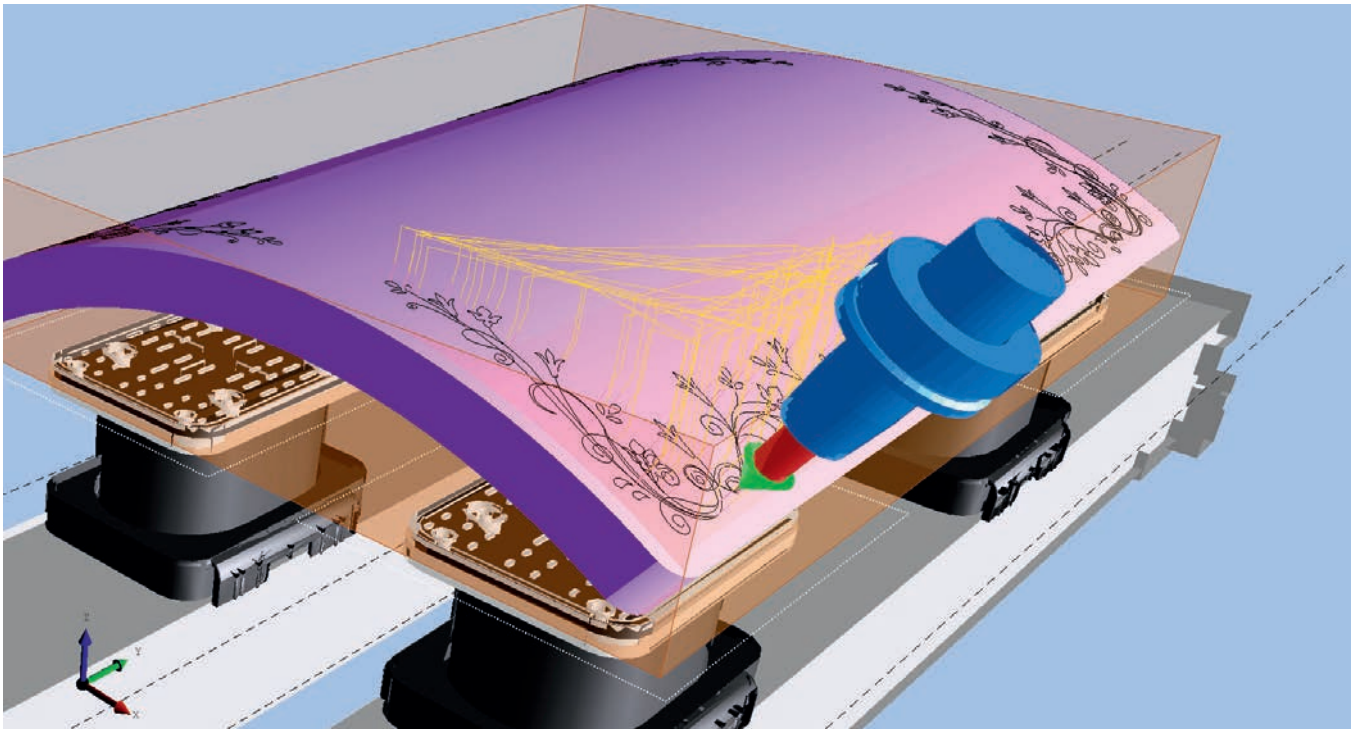

woodWOP CAM-Plugin

- CAD/CAM functions directly integrated into woodWOP
- Easy and fast import of 3D models or creation of 3D surfaces via integrated CAD plugin
- Automatic generation of the milling paths for roughing, finishing and formatting 3D objects
- Safe work, because the milling paths and the overrun movements are displayed graphically and simulated in woodWOP

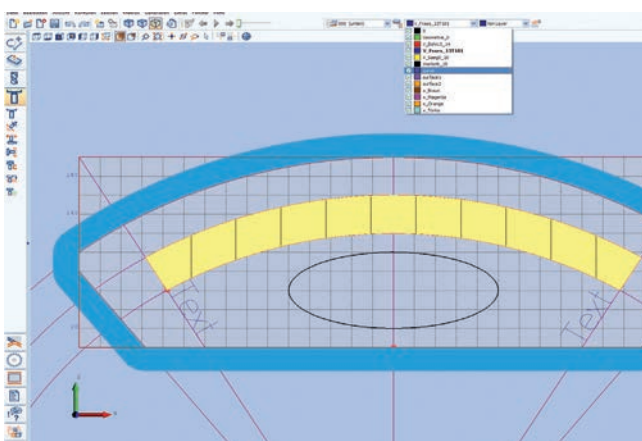

woodWOP CAD-Plugin

- CAD functions integrated directly into woodWOP
- Creation of your own CAD drawings on the machine and the work preparation station
- Import of CAD objects in the formats DXF, IGS, STP, STL

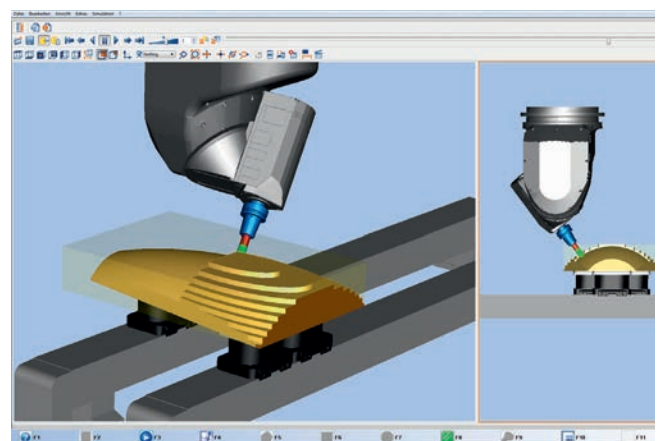

woodMotion – processing simulation of programs

- Optimal program preparation as running-in periods on the machine are reduced
- Simulation of 5-axis processing including material removal
- Display of the actual processing times and collision monitoring between tool and clamping elements
- Simulation based on a virtual 1:1 image of the machine configuration gives a very accurate picture of the real processing

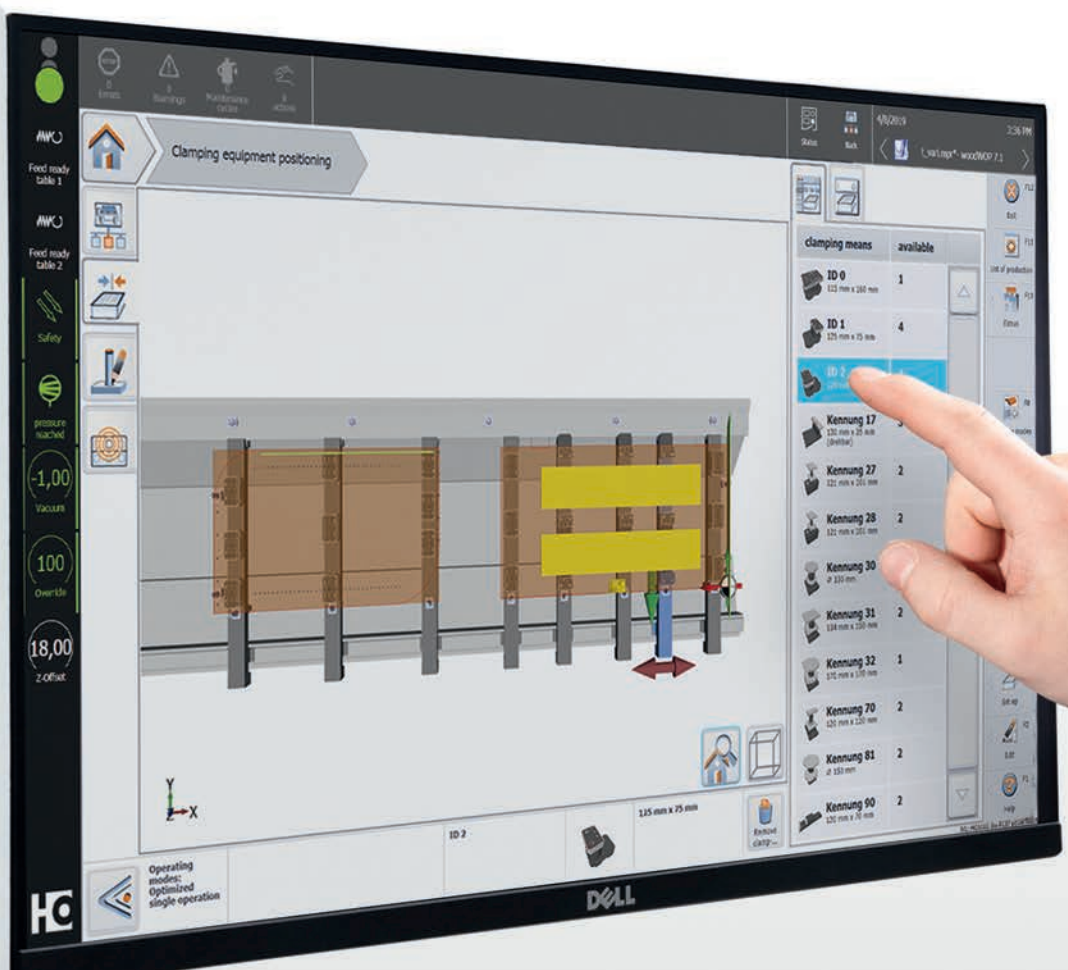

powerTouch PC87 with full touch operation

- 3D view of the machine bed, consoles, suction unit and workpiece
- Simple assignment using drag & drop
- Saving and loading of complete assignment situations
- Automatic location-specific suction unit recommendation with selectable suction unit types
- Manual clamping equipment positioning using touch under consideration of all travel areas

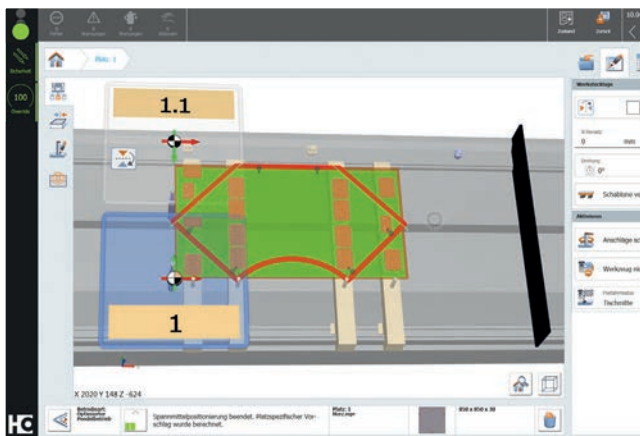

Slot assignment

- Can be operated completely by touch
- Simple assignment using drag & drop
- Preview of the woodWOP programs as a miniature view
- Assignment of parts with different thicknesses
- Saving and loading of complete assignment situations
- 3D view can be freely rotated
- 3D representation of machine bed, consoles, stop cylinders, suction unit and clamp, workpiece and processing

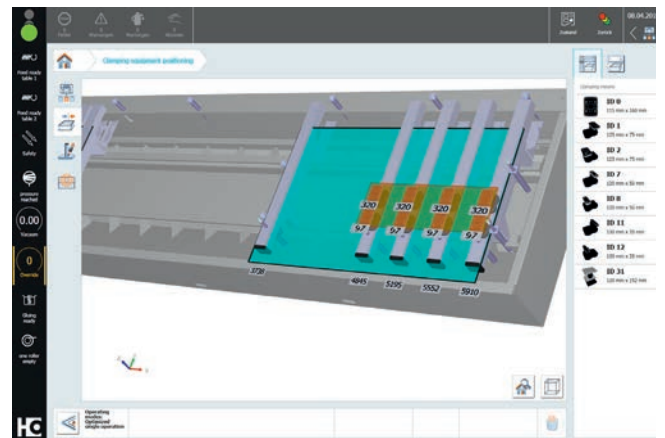

Automatic suction unit recommendation for workpiece or entire table

- Suction unit recommendation with preselection of suction unit types
- Processing tracks as an aid for positioning clamping equipment
- Manual clamping equipment positioning using touch under consideration of all travel areas
- Check of suction units already included in the woodWOP program
- Warning when suction units are not in the correct position

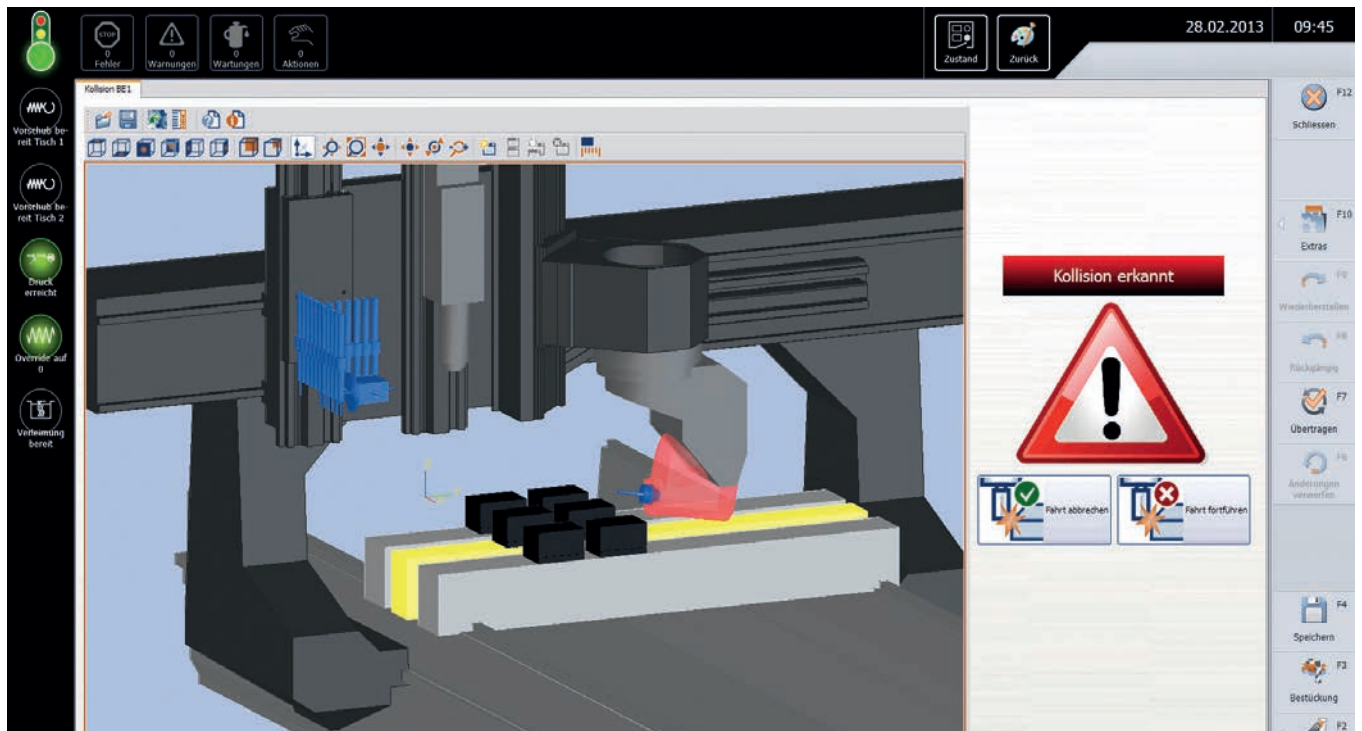

collisionControl – permanent security for your machine

- Monitors for potential collisions between machine components and clamping equipment during processing
- The machine stops automatically in the event of an imminent crash situation
- The crash situation is displayed as a snapshot with colored collision bodies
- The machine is displayed as an active 3D model in live mode



woodScout – help in your language

- Optional powerful diagnostic system
- Graphic display of the malfunction location on the machine
- Clear plain-text error messages in different languages
- Adaptive system through the allocation of causes and measures



Graphic tool data base

- Record quantities and actual operating times on the machine
- 3D representation of the tools and units
- Graphic setup of the tool changer using drag & drop

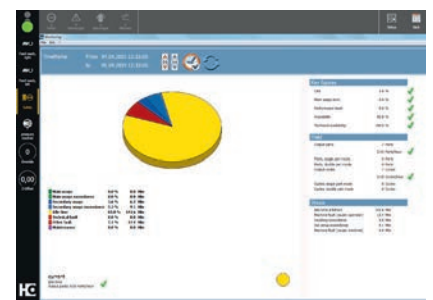

Machine data acquisition MMR – for a productive environment

- Record quantities and actual operating times on the machine
- Integrated maintenance instructions for optimum time and quantity-based planning, as well as performing maintenance
- Optional professional version allows detailed breakdown and logging of the recorded data

VALYOU

Our Mission, Your Performance.

Fast support:

94% resolution rate
via our hotline

Close to you:

1,350 service experts worldwide

We get things moving:

Over 1,000 worldwide spare parts
shipments each day

No one else has that:

Electronic documentation on over
150,000 machines, available in 28
languages

LIFE CYCLE SERVICES

Improved performance, more efficient processes, faster help, assurance of availability and smarter working.

VAL YOU comes from VALUE ADDED. Our objective is derived from this name: We create added value for your business by helping you get the most out of your processes. Every day.

Apps and digital assistants.

Quick and easy support in your machine environment.

Some people still use pen and paper to create their cutting patterns. But they look at their smartphone if they want to know what the weather is like – instead of looking out of the window. We asked ourselves: why not combine the best of both? Our apps and digital solutions make your everyday work easier: machines, material, tools, cutting patterns, components – you always have everything in your pocket or on your desk.



More information at digital.homag.com

WE HAVE DEVELOPED POWERFUL AND SMART SOLUTIONS FOR YOU:

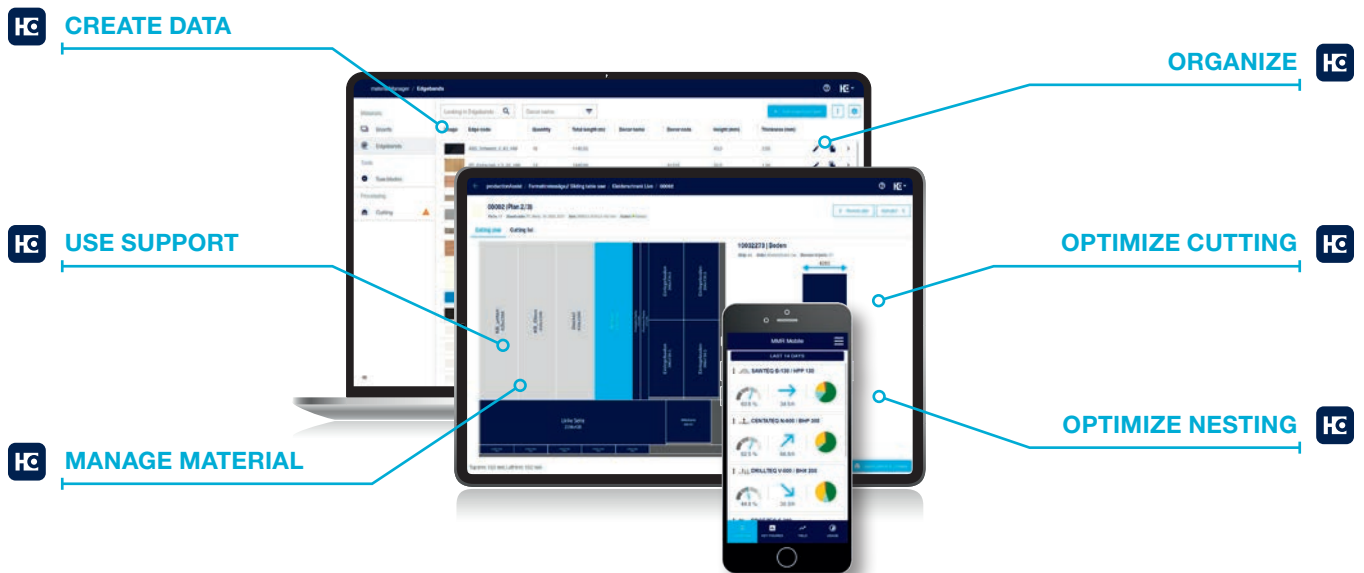

- ✓ Always low investment
- ✓ Always up to date (no updates necessary)
- ✓ Always easy to use (no complex software)
- ✓ Always helpful



Configurations Summary

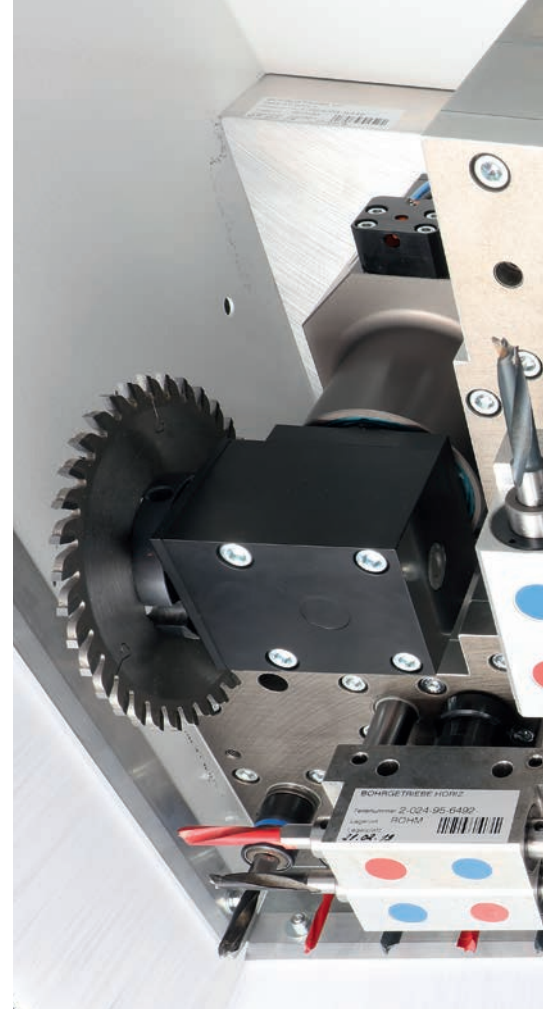





It's your choice. One package available for all current demands. Thus, all requirements are fulfilled.



		Spindle	C-axis	Optional interface
3-/4-axis	Classic	 Air-cooled 10 kW / 13.2 kW		
	Advanced			
5-axis	Classic	 DRIVE5CS Liquid-cooled 10 kW / 12 kW		Aggregate interface with 3-fold pneumatics
	Advanced			Aggregate interface with 3-fold pneumatics

Classic Universal basic configuration for furniture components and structural elements.
Advanced Increased performance in panel processing thanks to more drilling spindles.



Tool changer		Drilling gear				
14-fold tool changer	10-fold linear changer	Drilling [7500 High-Speed]			Grooving	
						
Moving in X		vertical	horizontal in X	horizontal in Y	Ø mm	0/90°
✓	✓	12	4	2	125	✓
✓	✓	21	6	4	125	✓
✓	✓	12	4	2	125	✓
✓	✓	21	6	4	125	✓

Standard: ✓

Option: ○

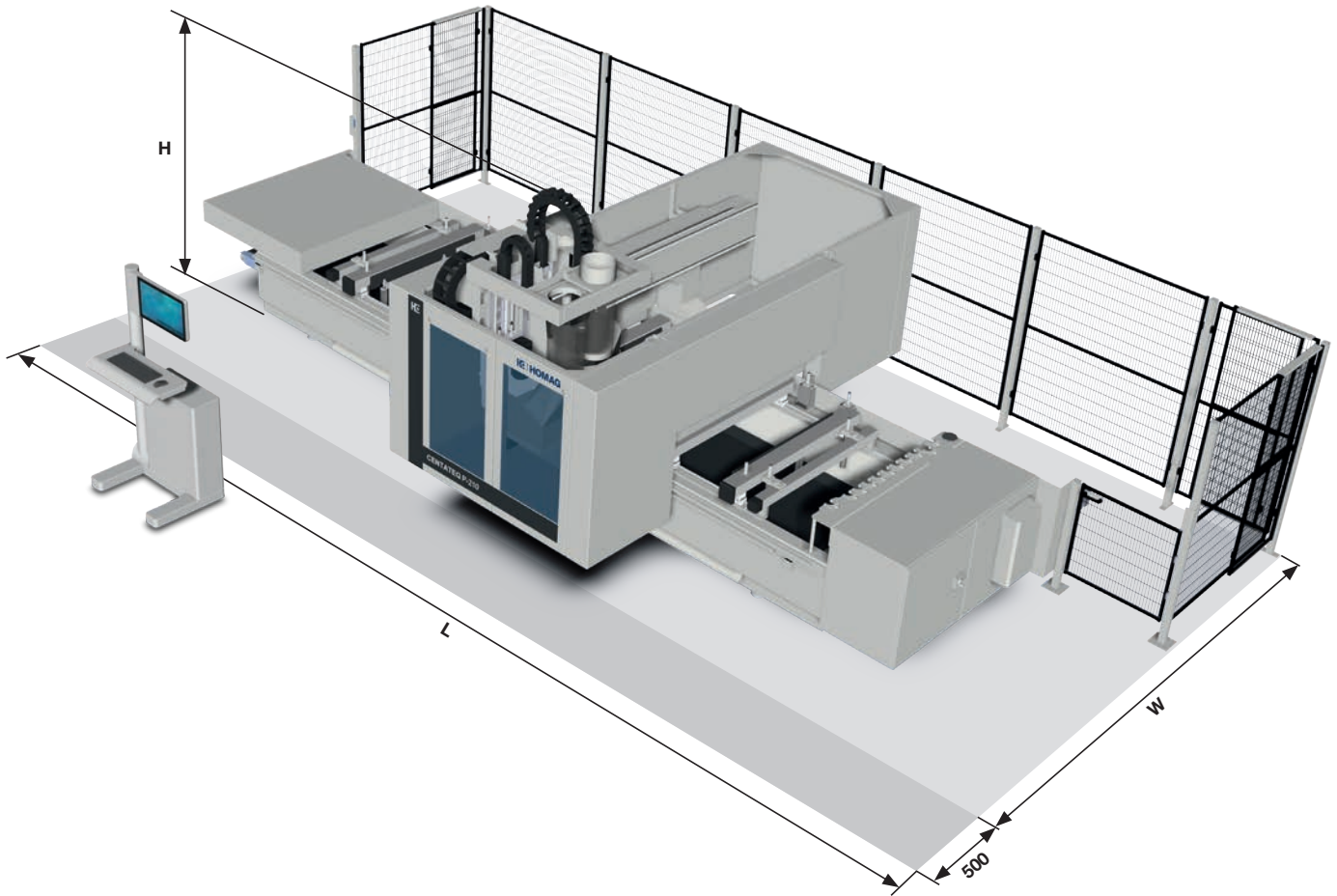

WORKING DIMENSIONS

Y = Workpiece width [mm/inch]	A = 0° with tool diameter 25 mm		A = 90° with tool length 195 mm / with all aggregates	Drilling / Loadable workpiece
	Rear stop		Rear stop	Rear stop
2 Z-axes	1,550 / 61.0		1,345 / 53.0	1,600 / 63.0

X = Workpiece length [mm/inch]	A = 90° with tool length 195 mm / with all aggregates	
	Individual processing	Alternating processing
/31	3,100 / 122.1	1,025 / 40.4
/42	4,200 / 165.4	1,575 / 62.0
/60	6,000 / 236.2	2,375 / 95.5

Z = Workpiece thickness [mm/inch]	from console	with clamping device H = 100 mm
		280 / 11,0

INSTALLATION DIMENSIONS

Machine type	Installation length [mm/inch]	Installation depth [mm/inch]	Installation height [mm/inch]
	L	W with 14-fold tool changer	H
/31	7,300 / 287.4	4,805 / 189.2	2,650 / 104.3
/42	8,400 / 330.7	4,805 / 189.2	2,650 / 104.3
/60	10,200 / 401.6	4,805 / 189.2	2,650 / 104.3

Technical data and photographs are not binding in every detail. We reserve the right to make changes during further development.



2 Z-AXES | CONSOLE TABLE

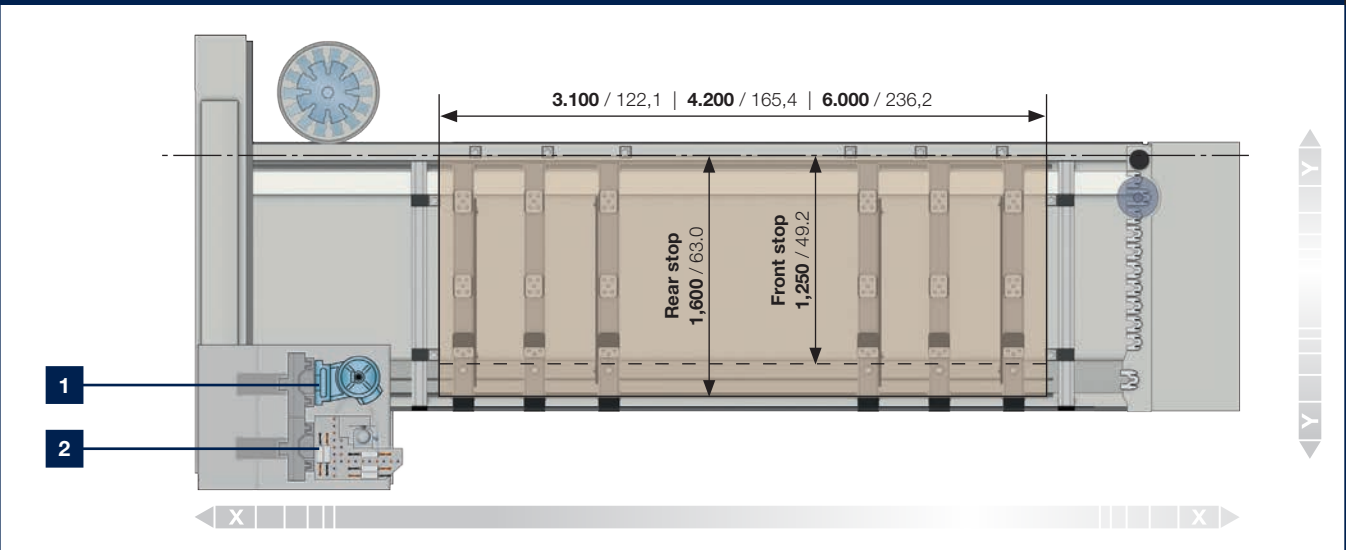

1 Routing spindle

2 Drilling gear

mm / inch

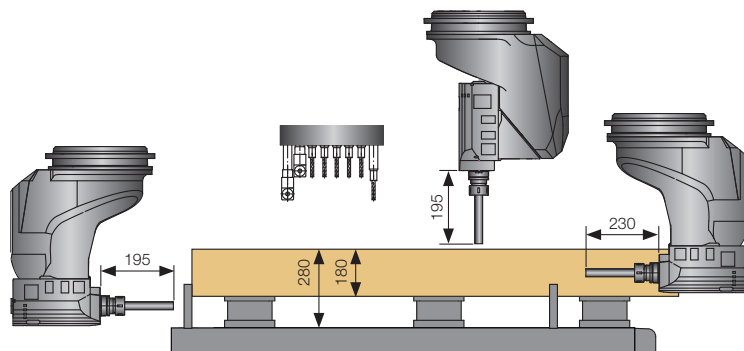

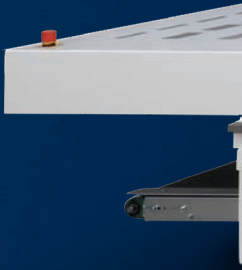

HOMAG Group AG

info@homag.com
www.homag.com

YOUR SOLUTION